

VARIANTE SZZ2 120 U120

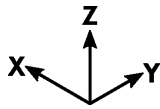

U120

X 1 226 mm
Y 460 mm
Z 13 mm

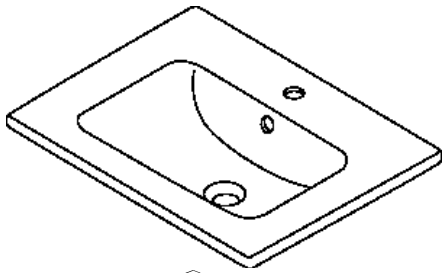

X 1200 mm
Y 445 mm
Z 520 mm

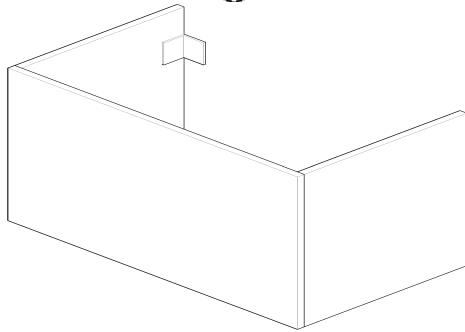

A



X 1200 mm
Z 520 mm
A 560 mm
B 610 mm
C 80-120 mm
D 600 mm
E --- mm
F --- mm
G 685 mm
H --- mm
I --- mm
J 860 mm

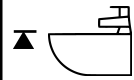
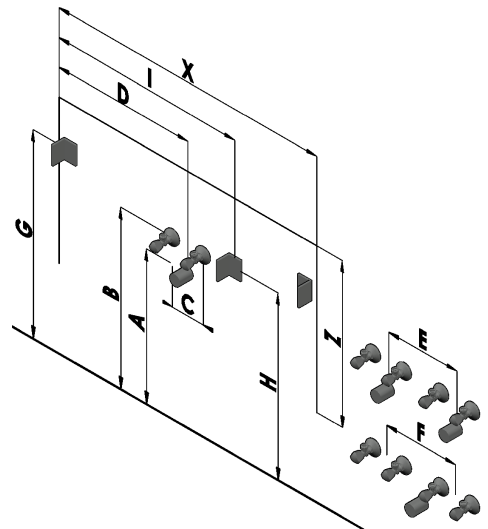

J  Art.No

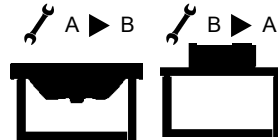
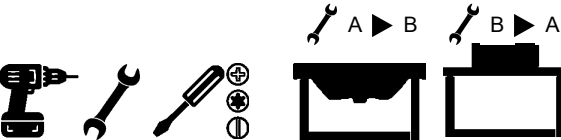

 max. 50 Kg

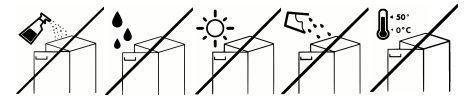

A

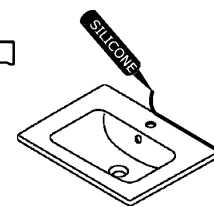
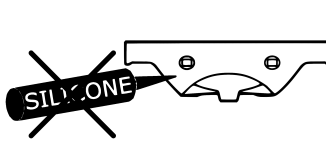
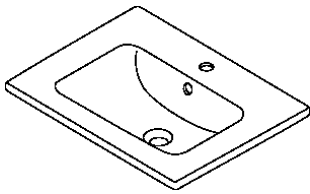

B

