

U112

X 0 mm  
Y 0 mm  
Z 0 mm

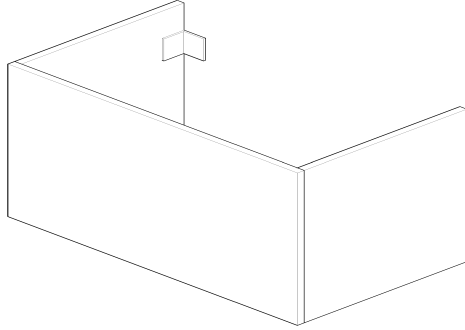

X 590 mm  
Y 448 mm  
Z 560 mm

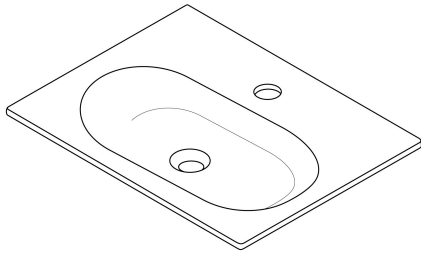

- A X 590 mm
- Z 560 mm
- A 550 mm
- B 600 mm
- C 80-120 mm
- D 295 mm
- E ... mm
- F ... mm
- G 692 mm
- H ... mm
- I ... mm
- J 860 mm

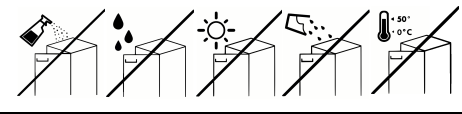
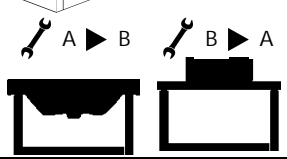
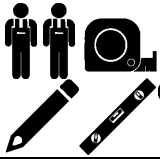
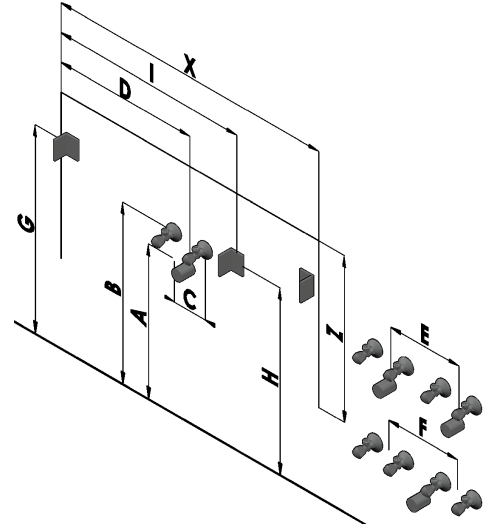

A

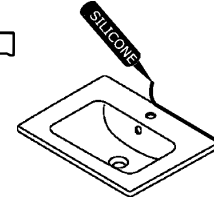
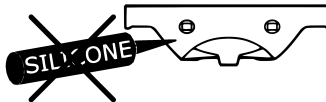
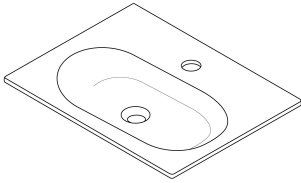

B

