



U116

X₁ 700mm

Y₁ 455mm

Z₁ 100mm

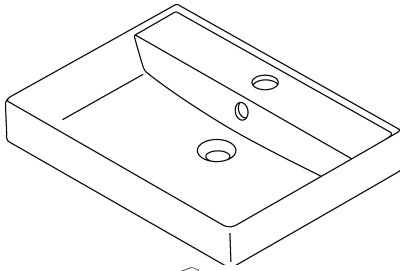

X 1000 mm

Y 500 mm

Z 418 mm

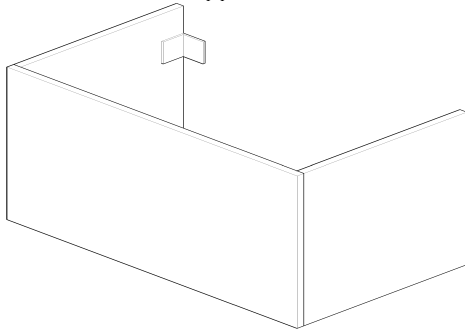

- A 560 mm
- B 600 mm
- C 80-100 mm
- D 500 mm
- E --- mm
- F --- mm
- G 691 mm
- H --- mm
- I --- mm
- J 860 mm
- M mm
- N mm

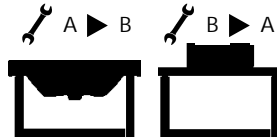

!

A=B

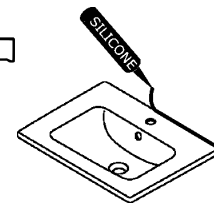
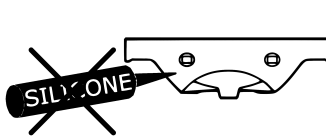
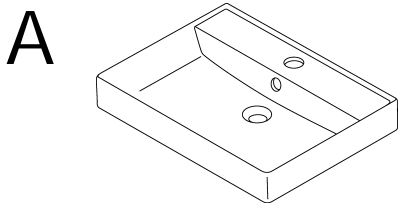
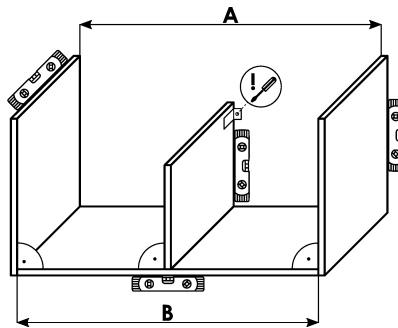

B

