



U115

X: 600mm

Y: 455mm

Z: 100mm

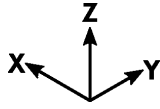

X: 800 mm

Y: 500 mm

Z: 318 mm

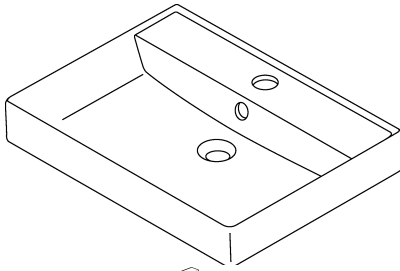

A

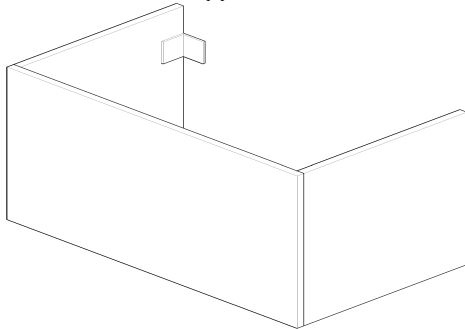

B



- A 560 mm
- B 600 mm
- C 80-100 mm
- D 400 mm
- E --- mm
- F --- mm
- G 691 mm
- H --- mm
- I --- mm
- J 860 mm
- M mm
- N mm

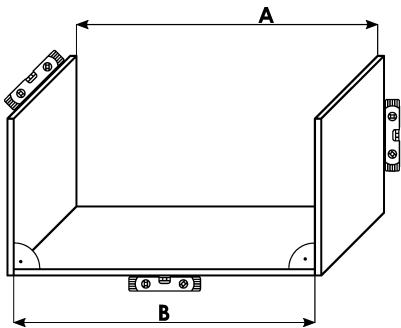
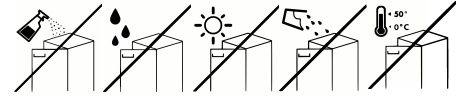
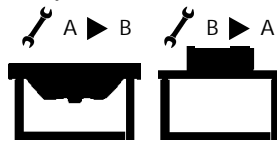
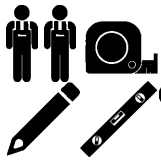
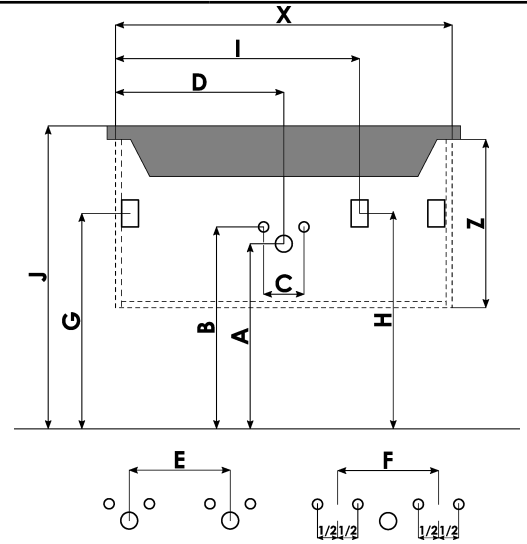

! A=B

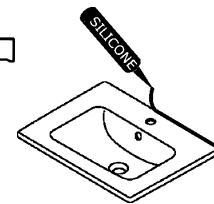
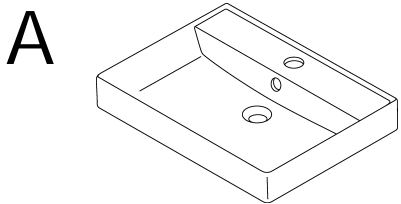
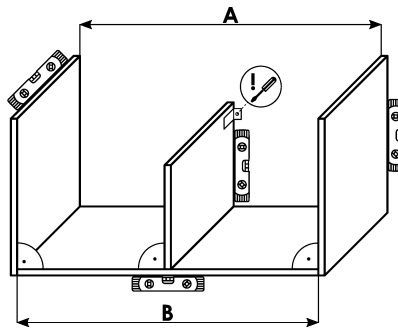

B

