



XXX

X: 0mm

Y: 0mm

Z: 0mm



X 900 mm

Y 500 mm

Z 400 mm



A



B



- A --- mm
- B --- mm
- C 80-120 mm
- D --- mm
- E --- mm
- F --- mm
- G mm
- H mm
- I mm
- J 860 mm
- M mm
- N 31 mm

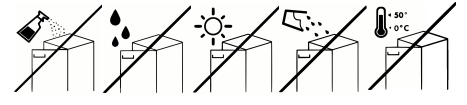
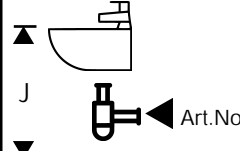
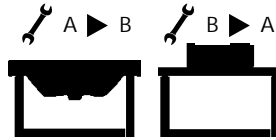
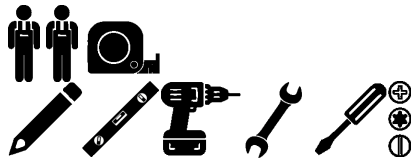
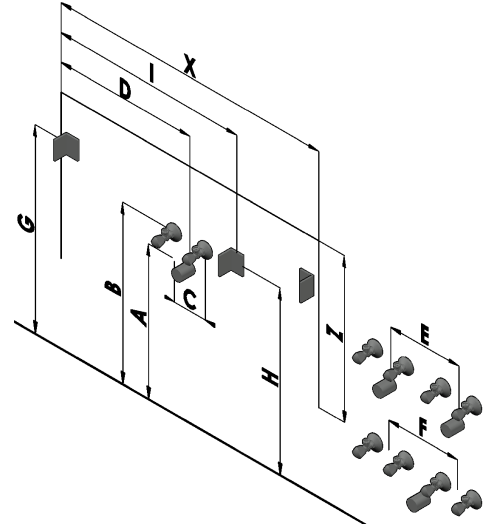

A

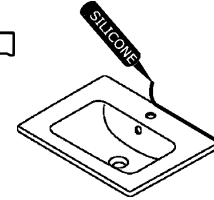
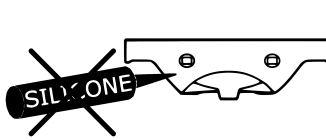

B

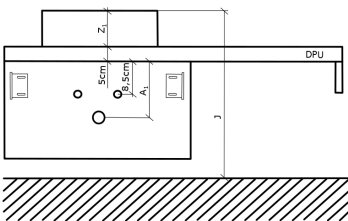
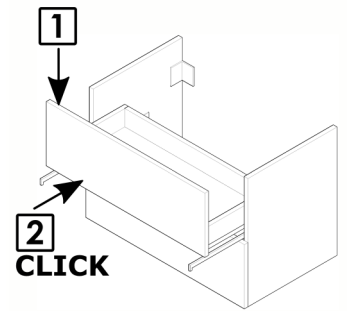
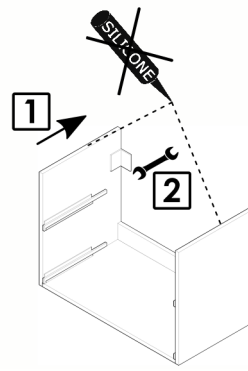
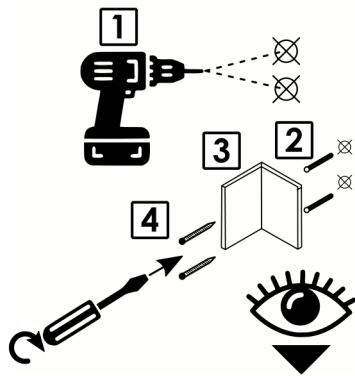
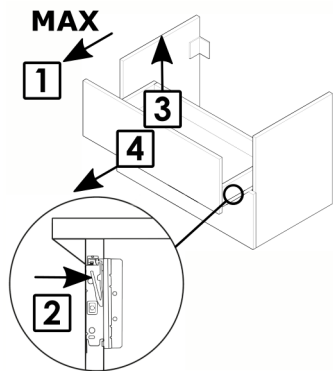

Z<sub>1</sub> = Triumph:

- SZZ A<sub>1</sub> = 80 mm
- SZZ1 A<sub>1</sub> = 80 mm
- SZZ2 A<sub>1</sub> = 80 mm

Z<sub>1</sub> = Kube, Joy, Joy 3:

- SZZ A<sub>1</sub> = 230 mm
- SZZ1 A<sub>1</sub> = 120 mm
- SZZ2 A<sub>1</sub> = 120 mm

