

XXX

X: 0mm

Y: 0mm

Z: 0mm



X 1000 mm

Y 500 mm

Z 300 mm

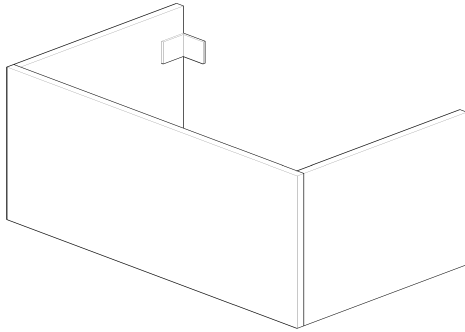

- A mm
- B mm
- C 80-120 mm
- D mm
- E mm
- F mm
- G mm
- H mm
- I mm
- J 860 mm
- M mm
- N 31 mm

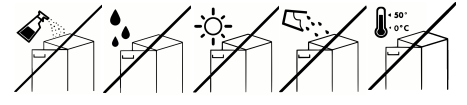
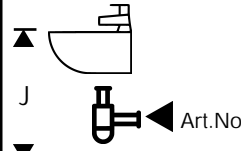
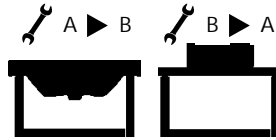
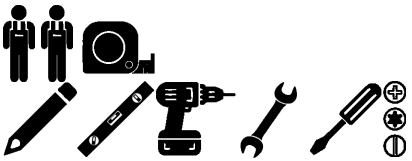
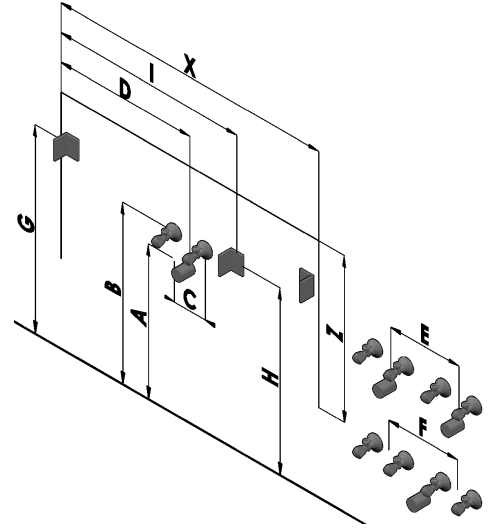

A

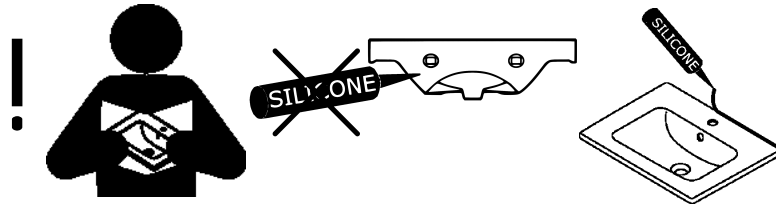

B

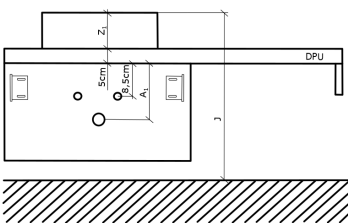
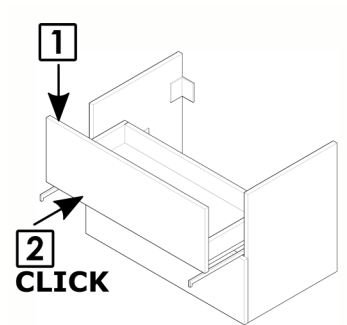
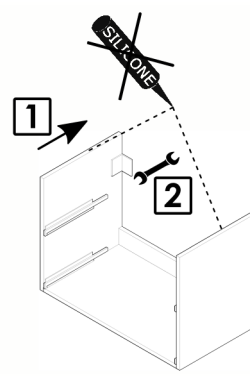
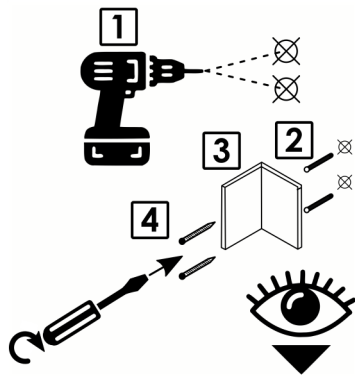
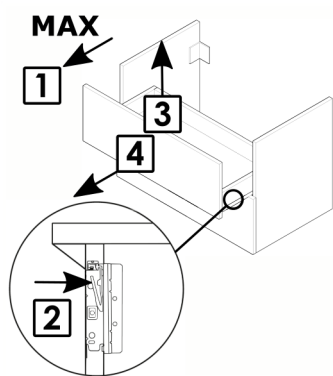

Z<sub>1</sub> = Triumph:

- SZZ A<sub>1</sub> = 80 mm
- SZZ1 A<sub>1</sub> = 80 mm
- SZZ2 A<sub>1</sub> = 80 mm

Z<sub>1</sub> = Kube, Joy, Joy 3:

- SZZ A<sub>1</sub> = 230 mm
- SZZ1 A<sub>1</sub> = 120 mm
- SZZ2 A<sub>1</sub> = 120 mm

