



XXX

X: 0mm

Y: 0mm

Z: 0mm



X 600 mm

Y 495 mm

Z 300 mm



A



A mm

B mm

C 80-120 mm

D mm

E mm

F mm

G mm

H mm

I mm

J 860 mm

M mm

N 31 mm

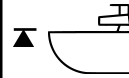
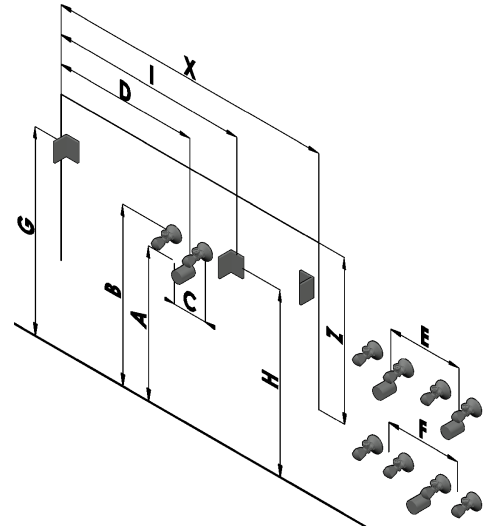

J

Art.No

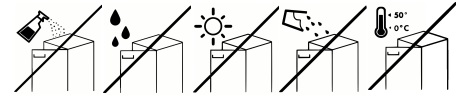
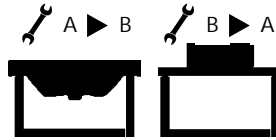
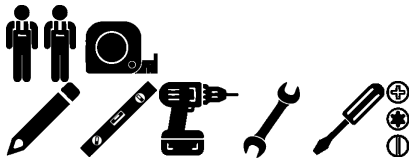

**A**

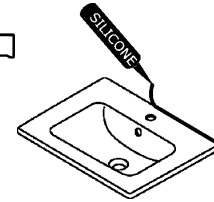
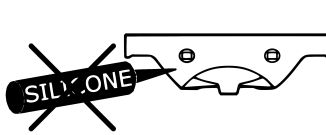

**B**

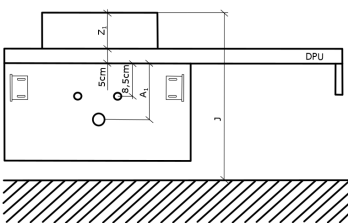
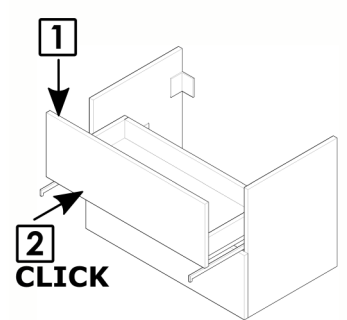
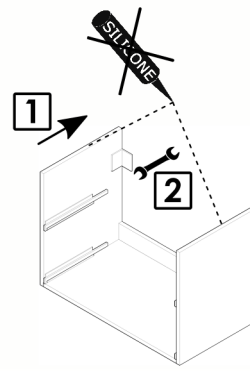
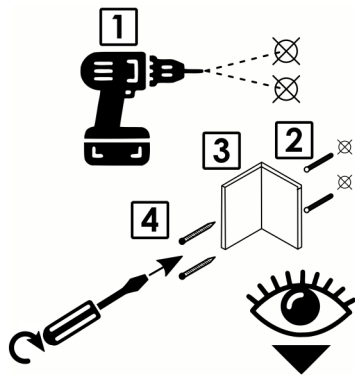
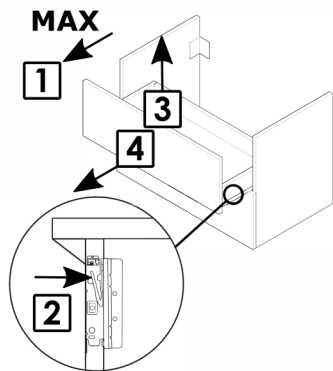

**Z<sub>1</sub> = Triumph:**

SZZ A<sub>1</sub> = 80 mm

SZZ1 A<sub>1</sub> = 80 mm

SZZ2 A<sub>1</sub> = 80 mm

**Z<sub>1</sub> = Kube, Joy, Joy 3:**

SZZ A<sub>1</sub> = 230 mm

SZZ1 A<sub>1</sub> = 120 mm

SZZ2 A<sub>1</sub> = 120 mm

