

X: 0mm

Y: 0mm

Z: 0mm

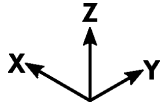

X 398 mm

Y 495 mm

Z 300 mm

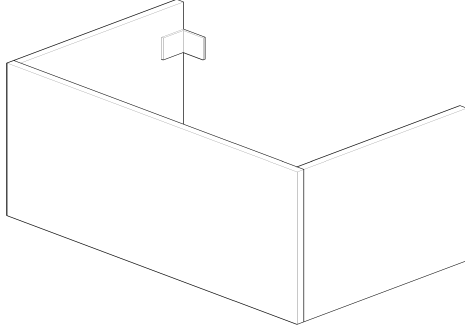

A



B



- A mm
- B mm
- C mm
- D mm
- E mm
- F mm
- G mm
- H mm
- I mm
- J mm
- M mm
- N 27 mm

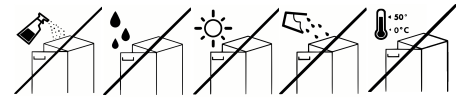
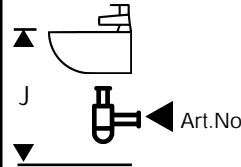
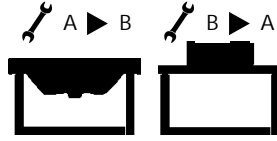
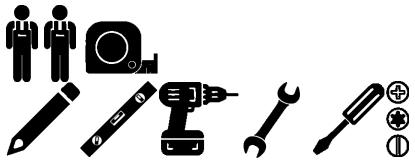
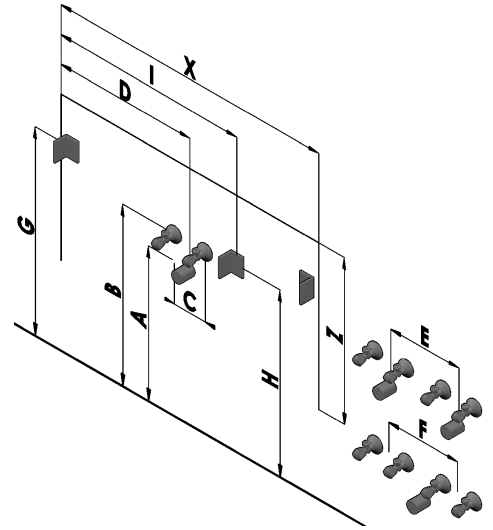

A

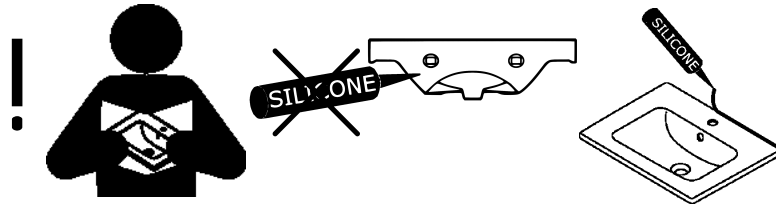

B

