

X 505 mm
Y 360 mm
Z 938 mm

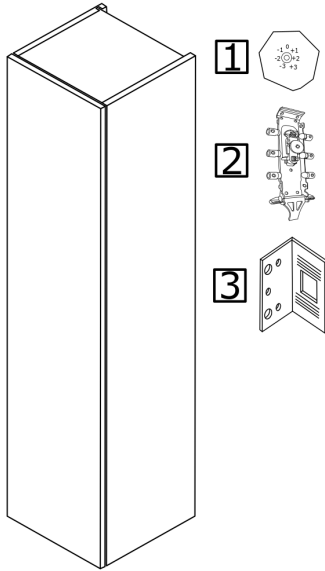

X 505 mm
Z 938 mm
A 60 mm
B 160 mm
C mm
D mm
E mm
F mm
G mm
H mm
I mm
J mm

